

# USER MANUAL

## BD510 SERIES

USER MANUAL / GUIDES / SOFTWARE  
INSTALLATION / WARRANTY



**BIG DOG**  
**SURVEILLANCE SYSTEMS**  
A DIVISION OF R.F. TECHNOLOGIES, INC.

# CONTENTS



- DVR Warranty
- DVR Software DVD
- Camera Installation
- DVR Installation
- DVR User Manual
- DVR Drivers / Microsoft Windows XP Home Edition
- Big Dog Surveillance Window Clings
- Extended Warranty / Virus Protection / Support

## Big Dog Surveillance Systems Are Made With the Latest In Surveillance Technology

In 1989, using the forefront of technology, R.F. Technologies, Inc. began its mission to provide hi-tech communication equipment. In 2002, R.F. Technologies, Inc. integrated digital surveillance, expanding on the mission and creating Big Dog Surveillance Systems.

By keeping the customers' needs and securities first and foremost, R.F. Technologies, Inc. has rapidly grown into an industry leader by offering the most advanced technology available.

## A Surveillance System Built For Any Environment

From alarms and notifications to motion detection and video archiving, Big Dog Surveillance Systems cover every possible need.

Whether you're a novice or a veteran to surveillance systems, it doesn't take long to see how easy the Big Dog Surveillance System is to install, configure, and operate. Built from the ground up, the interface has been designed for easy navigation and maximum efficiency.



**R.F. TECHNOLOGIES, INC.  
DIGITAL SURVEILLANCE SYSTEM (DSS)  
WARRANTY / EXCHANGE / REPAIR POLICY  
BD510 & BD1000 SERIES**



www.bigdogsurveillance.com

## **DSS OEM WARRANTY**

**With Power Protection:** 12 months from date of purchase on DVR unit and 90 days on other major component (cameras, power supply, monitor) parts. Excludes cables and connectors.

**TECHNICAL / INFORMATION SUPPORT:** Complimentary

**DVR ADVANCE EXCHANGE POLICY:** A defective DVR may be exchanged for a new unit within 15 days of purchase (not installation) date; free ground shipping using RFT prepaid labels. Customer will be invoiced at cost of new unit and credited upon receipt of defective unit.

Repair or replacement is at RFT's discretion (free shipping to RFT using our prepaid labels; customer pays return shipping). Warranty is non-transferable.

## **Warranty Disclaimer**

Manufacturer does not warrant against:

- Damage related to customer misuse, abuse, or alteration.
- Damage due to fire, wind, water, storm, riot, vandalism, war, act of God, burglary, power line fluctuations (increase or decrease), accident, or negligence.
- Damages or defects arising out of improper or abnormal product handling.
- Damages or defects arising from improper installation (where installation is by persons other than Manufacturer).
- Damage resulting from the failure to render routine attention to equipment such as: maintaining at least three inches of unrestricted space around the equipment to provide for proper air circulation and keeping all equipment free from harmful materials.
- Power damage without RFT **approved power protection**. Power protection sold separately for an additional \$350.
- Heat and / or environmental related damage.

## **Remote Access Disclaimer**

Manufacturer is not responsible for remote connection port forwarding or server accessibility. Server configurations are the sole responsibility of the customer.

## **Additional Extended & Expanded Warranty**

Additional extended & expanded warranty available within 30 days of purchase. Extended and expanded warranty provides 100% coverage of DVR unit and other major component parts to 2 years.

- 4 & 6 Cam Systems - \$500 Parts & Repair Labor; \$325 Repair Labor (Excludes Parts)
- 8 - Cam System - \$525 Parts & Repair Labor; \$350 Repair Labor (Excludes Parts)
- 16 - Cam System - \$575 Parts & Repair Labor; \$400 Repair Labor (Excludes Parts)
- 32 - Cam System - \$675 Parts & Repair Labor; \$500 Repair Labor (Excludes Parts)

## **DVR Rental**

Can be provided if available; customer pays \$125 per week plus shipping (invoiced at cost of new unit and credit memo issued upon receipt).

Manufacturer's employees' or representatives' oral or other written statements do not constitute a warranty, shall not be relied upon by the Buyer, and are not a part of the contract for sale or this warranty.

*RFT reserves the right to determine if damage was caused by customer's failure to provide a suitable environment or sufficient coverage for power related issues.*



## LEGAL DISCLAIMER

### LEGAL ISSUES: Regarding Audio Surveillance

United States Codes, Title 18, Section 2510 (2) states: "Oral communication means any "oral communication" uttered by a person exhibiting an expectation that such communication is not subject to interception under circumstances justifying such expectation." By definition of the code section, a person cannot have an expectation of privacy, nor can he or she expect that communication will not be intercepted, if there are public signs posted, indicating that the communication is being monitored. The First Amendment of the Constitution provides that any conversation between individuals is private, unless otherwise notified.

In simple terms, this means that ANY overhearing or recording of a conversation is illegal ... **unless both parties are aware that it is being done.** In order to comply with the law, R.F. Technologies, Inc. notifies all customers that a disclaimer stating, "**AUDIO MONITORING ON THESE PREMISES.**" MUST be affixed, IN PLAIN VIEW, to all entrances where microphones are installed. It is suggested that you notify your customer at the time that you install (or sell) the equipment that **DISCLAIMERS MUST BE IN PLAIN VIEW AT ALL ENTRANCES AND EXITS.**

In that some state laws may vary, it is further suggested that you consult with your local attorney, and become fully aware of the local laws in this regard. R.F. Technologies, Inc. will not be held responsible for any illegal actions committed by illegitimate use of audio/video recording equipment.

### LEGAL OVERVIEW: Surveillance & Recording

In general, most video recordings are legal in the U.S. with or without consent. Laws do exist regarding "Invasion of Privacy" which deal with the area of expected privacy. These include areas such as bathrooms, locker rooms, changing/dressing rooms, adult bedrooms, and other areas where a person should expect a high level of personal privacy. While the majority of laws dealing with video recording privacy issues tend to allow surreptitious recording and monitoring of video activity under most circumstances without notification of any of the parties involved, **it is highly recommended that you consult with your local or state law enforcement or an attorney who specializes in this area to comply with all local laws and regulations prior to utilization of video surveillance and monitoring.** It is also advised that notice/disclaimer of "Video Surveillance on These Premises," be prominently displayed in public areas.

# COLOR CCD DOME CAMERA INSTRUCTION MANUAL

## PRECAUTION

1. Be careful and avoid leaking water into the camera
2. Please do not shake or drop the camera
3. Please do not handle the surface of the lens
4. Power supply input should be correct
5. Avoid using the camera under the following conditions:
  - Do not focus directly on sun
  - Environment temp. higher than +50° C, or lower than -10° C
  - Humidity is higher than 90RH% or dewing condition

## INSTALLING & CONNECTING

Step-1: Using the screw to fix the bottom base on the ceiling.

Step-2: VIDEO Out and Power in.

Step-3: Adjust the position of Camera as you need.

Step-4: Install the cover, the transparent window in the front of the camera. Adjust for proper positioning.

Step-1.

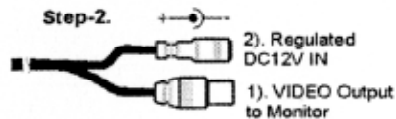
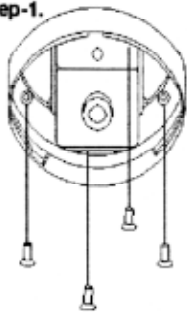

2). Horizontal view adjust (refer to Step-3-1.)

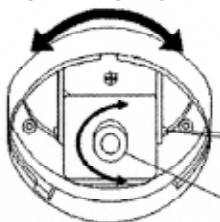

Step-3.

1). Tilt view adjust OK then lock

3). Adjust the lens focus

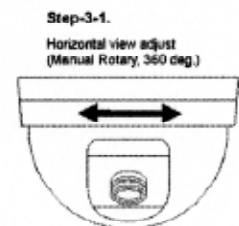

Step-4.

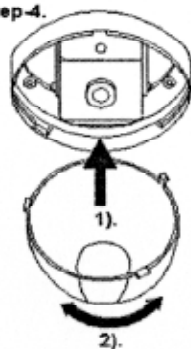

## PARTS

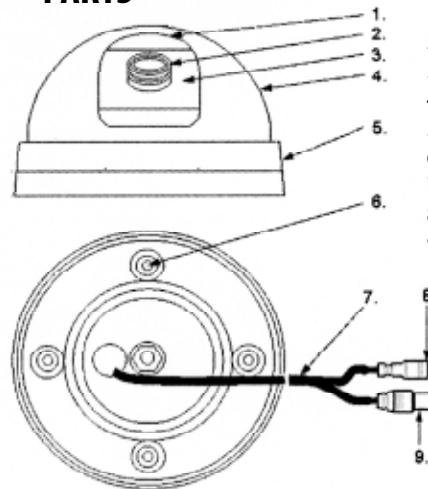

1. Window for cover
2. Lens of camera
3. Camera
4. Cover
5. Bottom Base
6. Screw hole for fixation \*4
7. Cable
8. DC JACK (ø2.0) for Power In
9. BNC(/F) JACK for Video Out

## ACCESSORIES

1. Instruction Manual \*1
2. Screws \*4



## TROUBLESHOOTING

- Is the system power on?
- Is the cable connected properly?
- Is the lens clear?
- Is the lens properly focused?
- Is the monitor properly adjusted?
- Is the montiro terminated properly?

## CONNECTIONS

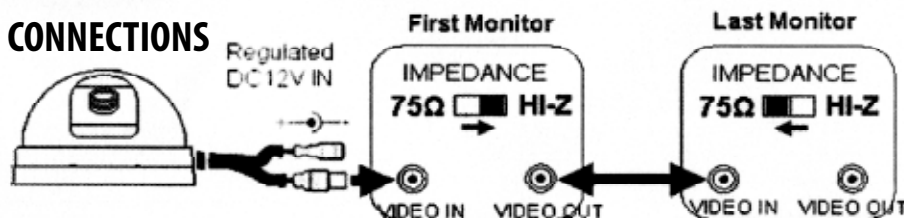

## POWER REQUIREMENTS

Never attach power leads to a POWER SUPPLY box while 120V AC power is active. Always turn off or unplug the power source prior to any work being done. Failure to do so may result in damage to your equipment and cause bodily harm.

The following is a list of equipment and the voltage requirements:

RFT P/N	Description	Voltage
120LED	Heavy duty indoor / outdoor LED camera	24VAC
24LED	Indoor / outdoor infrared LED camera	12VDC
CAMSMKNW	Smoke detector camera	12VDC
DOME	Indoor dome camera	12VDC
DOME5500	Vandal proof indoor / outdoor dome camera	12VDC / 24VAC
LTC045520	Indoor box camera	12VDC / 24VAC
MIC	Microphone	12VDC
VC-KIT-H26HB	Heated, metal, outdoor housing	24VAC

For items not listed, please check packaging and documentation for voltage requirements.

**Connecting equipment to incorrect power can result in damage and void warranty.**

If you have any questions or concerns, please contact technical support before continuing.

## POWER SUPPLY WARNING

Never attach power leads to a POWER SUPPLY box while 120V AC power is active. Always turn off or unplug the power source prior to any work being done. Failure to do so may result in damage to your equipment and cause bodily harm.

Before attaching any equipment to the power supply, make sure you are aware of each individual hardware's power requirement. Each power supply is clearly marked inside of the housing unit with specific voltage. Incorrectly attaching equipment to the wrong power source can result in damage and will not be covered under warranty.

## POWERVAR LINE CONDITIONERS

### What is the difference between a surge protector and power conditioner?

#### SURGE PROTECTORS

- **Clamping voltage** - this tells you what voltage will cause the MOVs to conduct electricity to the ground line. Generally, a clamping voltage more than 400V is too high.
- **Energy absorption** - This rating, given in joules, tells you how much energy the surge protector can absorb before it fails.
- **Response time** - Surge protectors don't kick in immediately; there is a very slight delay as they respond to the power surge. A longer response time tells you that your computer (or other equipment) will be exposed to the surge for a greater amount of time. All MOVs will burn out after repeated power surges, but the protector will still function as a power strip. Without an indicator light, you have no way of knowing if your protector is still functioning properly.



#### POWER CONDITIONERS

Ground Guard power conditioners are isolation transformer based, and are not rated in joules like a surge protector product. All products are injected with a 6000-volt, 1000k Hz, 500 amp ring-wave with a Key-Tek surge generator, simulating a lightning strike. To pass this testing the unit must withstand this test with a let thru voltage of less than 10 volts on normal mode (between hot and neutral) and less than on common mode (ground). The power conditioners response time is instantaneous, and they do not degrade the burn out over time like an MOV based surge protector.

**TECHNICAL SUPPORT  
1.800.598.2370**

Please refer to your manual for instructions on burning a CD / DVD, searching through video or audio, adjusting camera settings, adding users, and system setup.

**INSTRUCTIONS,  
MANUALS, AND ONLINE  
SUPPORT FILES FOR  
YOUR BIG DOG SYSTEM  
ARE ALSO  
AVAILABLE ONLINE**

[www.rftechno.com](http://www.rftechno.com)

**SECURE. PROTECT. DEFEND.  
ANTI-VIRUS / SPYWARE PROTECTION**

**MAY BE PURCHASED WITH YOUR BIG DOG SURVEILLANCE SYSTEM**

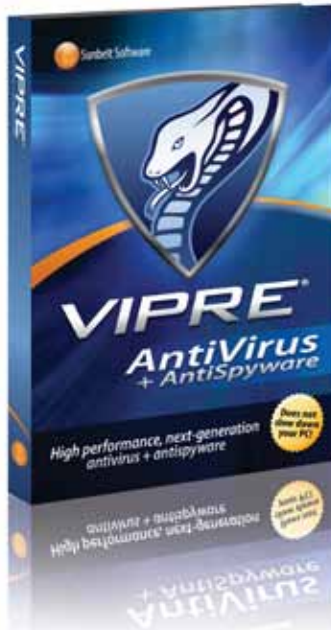

**COMPLETE PROTECTION FOR YOUR  
BIG DOG SYSTEM IS ONLY**

**\$25**

Sign up today and add all the benefits of Vipre® AntiVirus and AntiSpyware to new and existing Windows based Big Dog Surveillance Systems



For assistance downloading your software, please call technical support at 1-800-598-2370.

**THANK YOU FOR CHOOSING BIG DOG SURVEILLANCE SYSTEMS**

[www.bigdogsurveillance.com](http://www.bigdogsurveillance.com)

**Surveillance 1 Year Extended & Expanded Warranty**

1-year extended & expanded warranty available within 30 days, of purchase. Extended and expanded warranty provides 100% coverage of DVR unit and other major component parts to 2 years. Call for details.

**YES. I would like to purchase the following extended warranty:**

- 4 - Camera System - Parts & Labor \$500.00
- 4 - Camera System - Labor (Excludes Parts) \$325.00
- 8 - Camera System - Parts & Labor \$525.00
- 8 - Camera System - Labor (Excludes Parts) \$350.00
- 16 - Camera System - Labor & Parts \$575.00
- 16 - Camera System - Labor (Excludes Parts) \$400.00

Purchase Date \_\_\_\_\_

Tracking # \_\_\_\_\_

Serial #'s \_\_\_\_\_

\_\_\_\_\_

\_\_\_\_\_

Store Name \_\_\_\_\_

Contact \_\_\_\_\_

Address \_\_\_\_\_

City \_\_\_\_\_

State \_\_\_\_ Zip \_\_\_\_\_

Phone \_\_\_\_\_

**FAX OR MAIL TO:**

Big Dog Surveillance Systems • 542 South Prairie Street | Bethalto, IL 62010

Fax: (618) 377.1320 / Phone: (618) 377.2654



**BIG DOG**  
**SURVEILLANCE SYSTEMS**  
A DIVISION OF R.F. TECHNOLOGIES, INC.